



A Secondary lining chain tensioner locking pin (Y-4)
(Tool No. BMW 11 3 310)



A Adjustable primary lining chain tensioner tool (Y-4)
(Tool No. BMW 11 3 300)



A Cammesh installation tool (Y-4)
(Tool No. BMW 11 3 400)



A VMECC compressor air fitting
(Tool No. BMW 11 3 400)

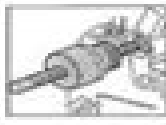

A Adjustable primary lining chain tensioner tool (Hyliner)
(Tool No. BMW 11 4 200)

Rear suspension Sport Wagon
(DHC with air springs)

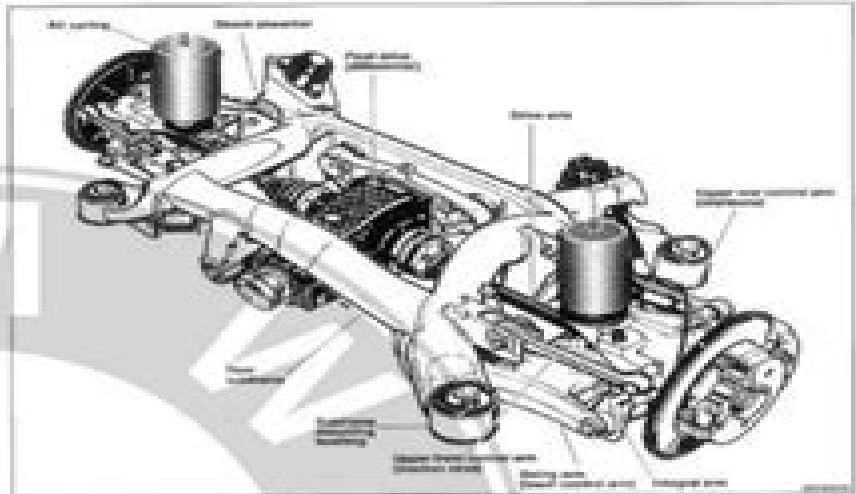

DHC uses a control suspension as necessary. The system offers the following features:

- Control system independent from vehicle engine and air-gas effect (hydraulic pump system)
- Individual control of rear wheels
- Unworn bush identified and compensated for
- Unworn metal surfaces identified and not compensated for
- Automatic control interrupted when cornering
- System operates using the BMW Service Tester (STB-...)

CAUTION
• Do not mark oxygen sensor connectors so that they can be identified as faulty.



- Disconnect rear axle hub nut/washer connectors from hub nut.
- Use small screwdriver to pry into corner of hub face (up on hub nut/washer 1 connector).
- Repeat for all hubs.
- Lift off connector from wheel and set aside.



- Unworn Schrader valve cap (detach from hub nut)
- Unworn hub face cap to release pressure
- Using a small screwdriver, compress air (pressure of 2 bar or 43.5 psi), blow hub face into hub face.

WARNING
• When a clean clean wheel is used, bring hub face (connecting) hub face pressure a pressure in that hub face.



www.epcdata1.com

Bmw 325i 1992 1998 Repair Service Manual

Charles O. Probst



Bmw 325i 1992 1998 Repair Service Manual:

Bentley BMW 3 Series Service Manual 1992-1998 Bentley Publishers,1999 If you re looking for better understanding of your E36 BMW look no further See and learn how to perform routine maintenance procedures with the highest level of clarity and comprehensiveness This in depth manual provides maintenance procedures for everything from brake fluid changes to resetting the service indicator Covers M3 318i 323i 325i 328i sedan coupe and convertible models 1992 98

Saab 900, 16 Valve Official Service Manual, 1985-1993 Bentley,Bentley Publishers,1993 These official Saab manuals are the only factory authorized comprehensive single source of service information and specifications available Whether you re a professional technician or a do it yourselfer these manuals will help you understand care for and repair your Saab Everything from fundamental automotive concepts and maintenance procedures to complex electrical system troubleshooting and complete engine overhaul is clearly explained Critical updates and information from the Saab Service Information Manual the Parts Service Information System and Saab Service Training have been included as well as fast proven repair procedures and tips used by Saab technicians

Volvo 240 Service Manual 1983 Through 1993 Bentley Publishers,1993 Vehicle Maintenance

Bentley BMW 5-Series 1989-95 Service Manual Bentley Publishers,1998-07-03 If you re looking for better understanding of your BMW look no further This manual provides the highest level of clarity and completeness for all service and repair procedures Covers 525i 530i 535i 540i including touring [BMW 3-series](#) Robert Bentley, inc,Bentley Publishers,1991 Engine coverage1 8 liter 4 cylinder B18 2 7 liter 6 cylinder B27 2 5 liter 6 cylinder B25 Transmission coverageGetrag 240 4 cylinder cars Getrag 260 6 cylinder cars [Bosch Fuel Injection and Engine](#)

[Management](#) C Probst,1989-11-27 This Bosch Bible fully explains the theory troubleshooting and service of all Bosch systems from D Jetronic through the latest Motronics Includes high performance tuning secrets and information on the newest KE and LH Motronic systems not available from any other source

BMW Enthusiast's Companion BMW Car Club of America,1995 BMW owners and BMW CCA members provide specific information for your BMW Valuable insights and technical information ranging from basic service tips to advanced driving theory Inside secrets on maintaining and preserving your BMW from properly washing and waxing your car to how to reset the service indicator lights Driving techniques ranging from basic car control to choosing apexes on the track Discover whether your car oversteers or understeers and how weight transfer affects traction and vehicle performance Learn the difference between torque and horsepower and how to select the right tires for your BMW Find out which performance modifications work which ones don t and why

[Ford Fuel Injection & Electronic Engine Control](#) Charles O. Probst,1993 The authoritative hands on book for Ford Engine Control Systems Author Charles Probst worked directly with Ford engineers trainers and technicians to bring you expert advice and inside information on the operation of Ford systems His comprehensive troubleshooting service procedures and tips will help you master your Ford s engine control system

101 Performance Projects for Your BMW

3 Series 1982-2000 Wayne R. Dempsey, 2006-09-15 Since its introduction in 1975 the BMW 3 series has earned a reputation as one of the world's greatest sports sedans. Unfortunately, it has also proven one of the more expensive to service and maintain. This book is dedicated to the legion of BMW 3 series owners who adore their cars and enjoy restoring, modifying, and maintaining them to perfection. Its format allows more of these enthusiasts to get out into the garage and work on their BMWs and, in the process, to save a fortune. Created with the weekend mechanic in mind, this extensively illustrated manual offers 101 projects that will help you modify, maintain, and enhance your BMW 3 series sports sedan. Focusing on the 1984-1999 E30 and E36 models, *101 Performance Projects for Your BMW 3 Series* presents all the necessary information, covers all the pitfalls, and assesses all the costs associated with performing an expansive array of weekend projects.

Supercharged! Design, Testing and Installation of Supercharger Systems Corky Bell, 2002-01-07 The supercharger has become a modern, environmentally friendly, and powerful piece of bolt-on equipment. For anyone interested in installing a system or just learning about them, this book is a must-have.

Thank you unconditionally much for downloading **Bmw 325i 1992 1998 Repair Service Manual**. Most likely you have knowledge that, people have seen numerous periods for their favorite books in the same way as this **Bmw 325i 1992 1998 Repair Service Manual**, but stop going on in harmful downloads.

Rather than enjoying a fine eBook subsequently a mug of coffee in the afternoon, then again they juggled in the same way as some harmful virus inside their computer. **Bmw 325i 1992 1998 Repair Service Manual** is genial in our digital library an online entry to it is set as public consequently you can download it instantly. Our digital library saves in fused countries, allowing you to acquire the most less latency time to download any of our books taking into account this one. Merely said, the **Bmw 325i 1992 1998 Repair Service Manual** is universally compatible when any devices to read.

https://stats.tinkerine.com/results/Resources/index.jsp/a_not_so_virgin_mary_based_on_a_true_story.pdf

Table of Contents **Bmw 325i 1992 1998 Repair Service Manual**

1. Understanding the eBook **Bmw 325i 1992 1998 Repair Service Manual**
 - The Rise of Digital Reading **Bmw 325i 1992 1998 Repair Service Manual**
 - Advantages of eBooks Over Traditional Books
2. Identifying **Bmw 325i 1992 1998 Repair Service Manual**
 - Exploring Different Genres
 - Considering Fiction vs. Non-Fiction
 - Determining Your Reading Goals
3. Choosing the Right eBook Platform
 - Popular eBook Platforms
 - Features to Look for in an **Bmw 325i 1992 1998 Repair Service Manual**
 - User-Friendly Interface
4. Exploring eBook Recommendations from **Bmw 325i 1992 1998 Repair Service Manual**
 - Personalized Recommendations
 - **Bmw 325i 1992 1998 Repair Service Manual** User Reviews and Ratings

- Bmw 325i 1992 1998 Repair Service Manual and Bestseller Lists
- 5. Accessing Bmw 325i 1992 1998 Repair Service Manual Free and Paid eBooks
 - Bmw 325i 1992 1998 Repair Service Manual Public Domain eBooks
 - Bmw 325i 1992 1998 Repair Service Manual eBook Subscription Services
 - Bmw 325i 1992 1998 Repair Service Manual Budget-Friendly Options
- 6. Navigating Bmw 325i 1992 1998 Repair Service Manual eBook Formats
 - ePub, PDF, MOBI, and More
 - Bmw 325i 1992 1998 Repair Service Manual Compatibility with Devices
 - Bmw 325i 1992 1998 Repair Service Manual Enhanced eBook Features
- 7. Enhancing Your Reading Experience
 - Adjustable Fonts and Text Sizes of Bmw 325i 1992 1998 Repair Service Manual
 - Highlighting and Note-Taking Bmw 325i 1992 1998 Repair Service Manual
 - Interactive Elements Bmw 325i 1992 1998 Repair Service Manual
- 8. Staying Engaged with Bmw 325i 1992 1998 Repair Service Manual
 - Joining Online Reading Communities
 - Participating in Virtual Book Clubs
 - Following Authors and Publishers Bmw 325i 1992 1998 Repair Service Manual
- 9. Balancing eBooks and Physical Books Bmw 325i 1992 1998 Repair Service Manual
 - Benefits of a Digital Library
 - Creating a Diverse Reading Collection Bmw 325i 1992 1998 Repair Service Manual
- 10. Overcoming Reading Challenges
 - Dealing with Digital Eye Strain
 - Minimizing Distractions
 - Managing Screen Time
- 11. Cultivating a Reading Routine Bmw 325i 1992 1998 Repair Service Manual
 - Setting Reading Goals Bmw 325i 1992 1998 Repair Service Manual
 - Carving Out Dedicated Reading Time
- 12. Sourcing Reliable Information of Bmw 325i 1992 1998 Repair Service Manual
 - Fact-Checking eBook Content of Bmw 325i 1992 1998 Repair Service Manual
 - Distinguishing Credible Sources

13. Promoting Lifelong Learning
 - Utilizing eBooks for Skill Development
 - Exploring Educational eBooks
14. Embracing eBook Trends
 - Integration of Multimedia Elements
 - Interactive and Gamified eBooks

Bmw 325i 1992 1998 Repair Service Manual Introduction

Bmw 325i 1992 1998 Repair Service Manual Offers over 60,000 free eBooks, including many classics that are in the public domain. Open Library: Provides access to over 1 million free eBooks, including classic literature and contemporary works. Bmw 325i 1992 1998 Repair Service Manual Offers a vast collection of books, some of which are available for free as PDF downloads, particularly older books in the public domain. Bmw 325i 1992 1998 Repair Service Manual : This website hosts a vast collection of scientific articles, books, and textbooks. While it operates in a legal gray area due to copyright issues, its a popular resource for finding various publications. Internet Archive for Bmw 325i 1992 1998 Repair Service Manual : Has an extensive collection of digital content, including books, articles, videos, and more. It has a massive library of free downloadable books. Free-eBooks Bmw 325i 1992 1998 Repair Service Manual Offers a diverse range of free eBooks across various genres. Bmw 325i 1992 1998 Repair Service Manual Focuses mainly on educational books, textbooks, and business books. It offers free PDF downloads for educational purposes. Bmw 325i 1992 1998 Repair Service Manual Provides a large selection of free eBooks in different genres, which are available for download in various formats, including PDF. Finding specific Bmw 325i 1992 1998 Repair Service Manual, especially related to Bmw 325i 1992 1998 Repair Service Manual, might be challenging as theyre often artistic creations rather than practical blueprints. However, you can explore the following steps to search for or create your own Online Searches: Look for websites, forums, or blogs dedicated to Bmw 325i 1992 1998 Repair Service Manual, Sometimes enthusiasts share their designs or concepts in PDF format. Books and Magazines Some Bmw 325i 1992 1998 Repair Service Manual books or magazines might include. Look for these in online stores or libraries. Remember that while Bmw 325i 1992 1998 Repair Service Manual, sharing copyrighted material without permission is not legal. Always ensure youre either creating your own or obtaining them from legitimate sources that allow sharing and downloading. Library Check if your local library offers eBook lending services. Many libraries have digital catalogs where you can borrow Bmw 325i 1992 1998 Repair Service Manual eBooks for free, including popular titles. Online Retailers: Websites like Amazon, Google Books, or Apple Books often sell eBooks. Sometimes, authors or publishers offer promotions or free periods for certain books. Authors Website Occasionally, authors provide excerpts or short stories for free

on their websites. While this might not be the Bmw 325i 1992 1998 Repair Service Manual full book , it can give you a taste of the authors writing style.Subscription Services Platforms like Kindle Unlimited or Scribd offer subscription-based access to a wide range of Bmw 325i 1992 1998 Repair Service Manual eBooks, including some popular titles.

FAQs About Bmw 325i 1992 1998 Repair Service Manual Books

1. Where can I buy Bmw 325i 1992 1998 Repair Service Manual books? Bookstores: Physical bookstores like Barnes & Noble, Waterstones, and independent local stores. Online Retailers: Amazon, Book Depository, and various online bookstores offer a wide range of books in physical and digital formats.
2. What are the different book formats available? Hardcover: Sturdy and durable, usually more expensive. Paperback: Cheaper, lighter, and more portable than hardcovers. E-books: Digital books available for e-readers like Kindle or software like Apple Books, Kindle, and Google Play Books.
3. How do I choose a Bmw 325i 1992 1998 Repair Service Manual book to read? Genres: Consider the genre you enjoy (fiction, non-fiction, mystery, sci-fi, etc.). Recommendations: Ask friends, join book clubs, or explore online reviews and recommendations. Author: If you like a particular author, you might enjoy more of their work.
4. How do I take care of Bmw 325i 1992 1998 Repair Service Manual books? Storage: Keep them away from direct sunlight and in a dry environment. Handling: Avoid folding pages, use bookmarks, and handle them with clean hands. Cleaning: Gently dust the covers and pages occasionally.
5. Can I borrow books without buying them? Public Libraries: Local libraries offer a wide range of books for borrowing. Book Swaps: Community book exchanges or online platforms where people exchange books.
6. How can I track my reading progress or manage my book collection? Book Tracking Apps: Goodreads, LibraryThing, and Book Catalogue are popular apps for tracking your reading progress and managing book collections. Spreadsheets: You can create your own spreadsheet to track books read, ratings, and other details.
7. What are Bmw 325i 1992 1998 Repair Service Manual audiobooks, and where can I find them? Audiobooks: Audio recordings of books, perfect for listening while commuting or multitasking. Platforms: Audible, LibriVox, and Google Play Books offer a wide selection of audiobooks.
8. How do I support authors or the book industry? Buy Books: Purchase books from authors or independent bookstores. Reviews: Leave reviews on platforms like Goodreads or Amazon. Promotion: Share your favorite books on social media or recommend them to friends.

9. Are there book clubs or reading communities I can join? Local Clubs: Check for local book clubs in libraries or community centers. Online Communities: Platforms like Goodreads have virtual book clubs and discussion groups.
10. Can I read Bmw 325i 1992 1998 Repair Service Manual books for free? Public Domain Books: Many classic books are available for free as they're in the public domain. Free E-books: Some websites offer free e-books legally, like Project Gutenberg or Open Library.

Find Bmw 325i 1992 1998 Repair Service Manual :

~~a not so virgin mary based on a true story~~

~~a pastors sketches conversations with anxious souls concerning the way of salvation~~

~~a modern introduction to differential equations second edition~~

a play of treachery a joliffe mystery

~~a practical guide to earned value project management second edition~~

a practical guide to ubuntu linux versions 810 and 804 2nd edition

~~a radiant life raw food and the presence of love~~

~~a morning at the office caribbean modern classics~~

a memory of two mondays

a problem solving approach to mathematics for elementary school teachers 11th edition

a mind for pool how to master the mental game

~~a practical guide to acupoints~~

a mediterranean society an abridgment in one volume

a precariat charter from denizens to citizens

~~a remarkable kindness a novel~~

Bmw 325i 1992 1998 Repair Service Manual :

homemade mac and cheese allrecipes - Sep 02 2023

web oct 6 2023 these are the ingredients you'll need to make the best homemade mac and cheese of your life macaroni this homemade mac and cheese starts with a box of uncooked macaroni noodles butter and flour you'll need butter and flour to make a roux for the cheese sauce you'll also need two tablespoons

creamy baked mac and cheese the chunky chef - Jun 30 2023

web sep 30 2019 looking for other comfort food dishes check out my homemade sloppy joes creamy broccoli cheddar soup crockpot meatloaf and homestyle no boil mashed potatoes baked mac and cheese baked mac and cheese it s nearly the universal comfort food and there are so many variations

the very best mac and cheese recipe epicurious - Dec 25 2022

web oct 25 2023 the best mac and cheese recipes used a combination of cheeses we landed on extra sharp cheddar yellow or white cheddar are both fine and parmesan as our ultimate duo but you can make

best mac and cheese recipe easy recipe guide jamie oliver - Aug 01 2023

web ingredients 10 cloves of garlic 45 g butter 3 heaped tablespoons plain flour 6 bay leaves 1 litre semi skimmed milk 600 g dried macaroni

easy homemade mac and cheese tastes better from scratch - Oct 03 2023

web aug 27 2019 instructions preheat the oven to 325 degrees and lightly grease a square baking dish cook the macaroni to al dente according to package instructions drain and set aside melt the butter in a medium saucepan over medium heat blend in the flour salt and pepper cook for 2 minutes slowly add the

best ever macaroni cheese recipe bbc good food - May 30 2023

web this macaroni cheese recipe is easy and delicious perfect for a quick lunch or dinner find more recipe inspiration at bbc good food this perfect baked macaroni cheese recipe comes with a creamy cheese sauce a hint of mustard and uses leftover french stick for its crunchy topping

best homemade macaroni and cheese recipe southern living - Jan 26 2023

web jun 2 2023 melt the butter flour and cream and bring the sauce to a simmer and then mix in the shredded cheese mix cheese with the pasta transfer the mac and cheese to a baking tray and top with more cheese bake the mac and cheese make sure the top is golden brown and then it s ready to serve cooking tips for the best mac and cheese

simple stay home recipes creamy mac cheese seth lui com - Mar 28 2023

web apr 13 2020 500g dried elbow macaroni ½ cup unsalted butter ½ cup all purpose flour 1 ½ cups whole milk 2 ½ cups half and half 4 cups grated cheddar cheese feel free to change it up 2 cups grated mozzarella cheese feel free to change it up ½ tablespoon salt ½ teaspoon ground black pepper ¼ teaspoon paprika tools pot saucepan

macaroni and cheese recipes - Feb 24 2023

web recipes main dishes pasta macaroni and cheese from creamy baked macaroni and cheese to stovetop versions with bacon explore hundreds of easy comforting mac and cheese recipes baked macaroni and cheese stovetop macaroni and cheese chili dog mac and cheese 11 ratings smoked mac and cheese is perfect for all your

baked mac and cheese recipetin eats - Apr 28 2023

web nov 21 2021 pasta all the essential food groups covered best pasta for mac and cheese macaroni also known as elbow pasta but really any short pasta will work just fine penne ziti twirls etc best cheese for mac and cheese a combination of gruyere and mozzarella cheese

passing it on on apple books - Jan 12 2023

myles munroe has observed that the tendency among leaders is to deal with this question as serious circumstances or retirement loom further it is his belief that this is one of the most important decisions a leader will ever make

passing it on growing your future leaders myles munroe - Jun 17 2023

may 25 2011 this book is a wakeup call myles munroe wants all leaders to focus on building the right team for the future and to make it a top priority because the process is not a quick one

pass it on myles munroe kshs 1 500 linkedin - Feb 01 2022

aug 14 2018 the power of passing it on by dr myles munroe the greatest act of leadership is mentoring if what you learn achieve accumulate or accomplish dies with you then you are a generational failure

passing it on growing your future leaders google play - Nov 10 2022

passing it on growing your future leaders ebook written by myles munroe read this book using google play books app on your pc android ios devices download for offline reading

passing it on growing your future leaders by myles munroe - Dec 11 2022

may 25 2011 myles munroe has observed that the tendency among leaders is to deal with this question as serious circumstances or retirement loom further it is his belief that this is one of the most important decisions a leader will ever make this book is a wakeup call

passing it on growing your future leaders myles munroe - May 16 2023

jan 1 2011 myles munroe passing it on growing your future leaders hardcover january 1 2011 by myles munroe author 4 8 87 ratings see all formats and editions kindle 9 99 read with our free app hardcover 114 76 5 used from 114 75

passing it on myles jr charisa munroe youtube - Aug 19 2023

aug 7 2017 passing it on myles jr charisa munroe munroe global 867k subscribers subscribe 3 4k share 193k views 6 years ago drmylesmunroe mylesmunroe mylesmunroejr you can purchase the complete

book free pdf passing it on myles munroe download - Mar 02 2022

books biography pastor phil hopper senior pastor abundant life baptist church book dr pastor paul enenche reasons for living free pdf download book free pdf passing it on myles munroe download

passing it on by dr myles munroe the principles and power of - Jun 05 2022

by olusegun iyejare october 19 2022 dr myles munroe understood the place of continuity in leadership and left a powerful

blueprint for effective mentorship and succession in his book passing it on in this post i ll be sharing the definition principles and power of mentorship as taught by dr myles munroe

the most important aspect of leadership passing it on dr myles munroe - Jul 18 2023

apr 27 2018 the most important aspect of leadership passing it on dr myles munroe munroe global 871k subscribers subscribe 278k views 5 years ago drmylesmunroe mylesmunroe you can purchase the

passing it on by myles munroe ebook ebooks com - Sep 08 2022

myles munroe has observed that the tendency among leaders is to deal with this question as serious circumstances or retirement loom further it is his belief that this is one of the most important decisions a leader will ever make this book is a wakeup call

passing it on growing your future leaders munroe myles - Sep 20 2023

may 25 2011 myles munroe has observed that the tendency among leaders is to deal with this question as serious circumstances or retirement loom further it is his belief that this is one of the most important decisions a leader will ever make this book is a wakeup call

myles munroe wikipedia - Jul 06 2022

myles munroe obe 20 april 1954 9 november 2014 was a bahamian evangelist and ordained minister avid professor of the kingdom of god author speaker and leadership consultant he founded and led the bahamas faith ministries international bfmi and myles munroe international mmi

passing it on growing your future leaders hardcover - Mar 14 2023

may 25 2011 buy passing it on growing your future leaders by munroe dr myles isbn 9780446580472 from amazon s book store everyday low prices and free delivery on eligible orders

the most important aspect of leadership passing it on dr myles munroe - May 04 2022

bit ly helloek here is my complete list of recommended resources for self education bit ly helloek

passing it on by myles munroe hachette book group - Apr 15 2023

may 25 2011 myles munroe has observed that the tendency among leaders is to deal with this question as serious circumstances or retirement loom further it is his belief that this is one of the most important decisions a leader will ever make

passing it on dr myles monroe youtube - Apr 03 2022

60 seconds clipped by purposefultime dr maunda charles original video the most important aspect of leadership passing it on dr myles munroe by m

passing it on growing your future leaders hardcover - Feb 13 2023





myles munroe has observed that the tendency among leaders is to deal with this question as serious circumstances or retirement loom further it is his belief that this is one of the most important decisions a leader will ever make



passing it on by myles munroe hachette book group - Oct 09 2022

passing it on growing your future leaders open the full size image loading contributors by myles munroe formats and prices price 9 99 price

passing it on by myles munroe overdrive - Aug 07 2022

may 25 2011 passing it on shows how to use the concept of mentoring within an organization to value the distinct talents and abilities of the individuals mentoring is the pathway to developing leaders from within leaders who are in line with the goals of the organization leaders who are most likely to adopt and carry a vision forward

chhota bheem     *polo challenge* - Aug 01 2022

web mar 19 2022 chhota bheem     polo challenge cartoons for kids in tamil green gold tamil 279k subscribers 1 7m views 1 year ago here comes another exciting chhota bheem video in tamil

chota bheem old episode alibaba cave part 1 video dailymotion - Feb 24 2022

web jan 14 2023 watch chota bheem old episode alibaba cave part 1 master moviez on dailymotion

pogo live schedule today tvgenie - Mar 08 2023

web tv genie live movie schedule for tv addicts pogo schedule 955 670 chhota bheem 11 15 pm today live chhota bheem 11 30 pm today super bheem 12 00 am

top 197 all cartoons in pogo tariquerahman net - Mar 28 2022

web mar 8 2023 10 best shows on pogo that made our childhood awesome wirally children s day from power rangers dexter s laboratory to pokemon and phineas and ferb my kolkata readers pick the cartoon and animated shows that made childhood fun telegraph india pogo shows archives media india group

bheem ki shakti bheem cartoon pogo memes dailymotion - Nov 04 2022

web mar 17 2023 watch bheem ki shakti bheem cartoon pogo memes divyanshu upadhyay on dailymotion

chhota bheem dholakpur ka khufia jahaz cartoons for - Aug 13 2023

web apr 13 2020 green gold animation presents chhota bheem captain of the ship dholakpur ka jahaz now you can bring home the fun own your favorite chhota bheem krishna balram mighty raju chorr police

cartoon tv shows chhota bheem pogo tv - Oct 03 2022

web watch your favourite cartoon show chhota bheem only on pogo tv visit to know about schedule and timings

[super bheem cartoon tv shows pogo tv](#) - Jan 26 2022

web watch your favourite cartoon show super bheem only on pogo tv visit to know about schedule and timings toggle

navigation home games shows toggle navigation home games shows games downloads about super bheem s gang super bheem is the valiant super hero of all the galaxies combined

list of programmes broadcast by pogo wikipedia - Jan 06 2023

web this is a list of television programs currently and formerly broadcast by pogo the channel was launched on 1 january 2004 and airs mainly animated programmings a variation of pogo s current logo used since 2016 current programming baby little singham 1 chhota bheem 2 little krishna 3 little singham 4 mighty little bheem 5

pogo live pogo live tv video dailymotion - Apr 28 2022

web aug 1 2020 your queries 1 pogo live 2 pogo live tv 3 pogo tv live 4 pogo tv channel live 5 pogo live streaming 6 pogo live stream 7 live pogo 8 live pogo tv 9 bheem live 10 chota bheem cartoon 11 chota bheem cartoon live 12 chota bheem live 13 pogo cartoon channel 14 pogo cartoon channel live 15 pogo channel live app link

pogo youtube - Jun 11 2023

web about titoo play all get ready to laugh and embark on exciting adventures with titoo the mischievous and lovable cartoon character join him and his friends in a world of fun and imagination

chhota bheem dholakpur school 📺 📺 📺 📺 📺 📺 **cartoons** - Jul 12 2023

web oct 13 2023 139k 14m views 1 year ago it s time for school uniforms polishing shoes morning assembly new classrooms chhota bheem his friends are back to school for a new academic year kids are

pogo comic strip wikipedia - Dec 05 2022

web simon schuster fantagraphics books gregg press eclipse comics spring hollow books genre s humor satire politics pogo was a daily comic strip that was created by cartoonist walt kelly and syndicated to american newspapers from 1948 until 1975

super bheem cartoon tv shows pogo tv - Sep 14 2023

web welcome to pogo the best place for kids we offer many free online games show information and cool downloads you can know all about your favourite cartoon characters like chhota bheem kris smaashhing simmba titoo lambug tingug dabangg grizzly and the lemmings and more

pogo tv game bhaag bheem superbheem game - May 30 2022

web we offer many video clips free online games cool downloads and loads of free prizes you can find all the details of your favourite cartoon characters like chhota bheem mighty raju tom jerry mr bean yo kai watch new looney tunes grizzly and the lemmings oddbods the happos family appu the yogic elephant and many more

chhota bheem adventure of persia 2023 dual audio hindi bolt - Feb 07 2023

web sep 20 2023 chota bheem racing sports car chhota bheem cartoon games for kids maqsood rajpoot bhatti 03004306138

1 17 chota bheem cartoons hindi urdu tamil watch chhota bheem cartoon 2016 premiumlink 1 31 watch chota bheem cartoon video full 2015 in hind urdu tamil online free cartoons

chhota bheem dholakpur kindergarten youtube - Sep 02 2022

web feb 1 2018 subscribe 218k 106m views 5 years ago chhotabheem dholakpur kindergarten green gold animation presents chhota bheem dholakpur kindergarten subscribe for more videos bit ly

cartoon tv shows chhota bheem pogo tv - Apr 09 2023

web bheem is an adventurous and fun loving nine year old who is gifted with extraordinary strength this power is a boon for dholakpur bheem s village which is constantly under threat this little kid has a big heart and he always uses his strength to help those who are wronged or needy

pogo tv kids tv channel kids cartoon shows games - Jun 30 2022

web welcome to pogo the best place for kids we offer many free online games show information and cool downloads you can know all about your favourite cartoon characters like chhota bheem kris smaashhing simmba titoo lambug tingug dabangg grizzly and the lemmings and more

bheem journey to petra part 01 pogo youtube - May 10 2023

web oct 13 2023 bheem journey to petra part 01 pogo your queries bheem cartoon pogo bheem cartoon pogo tv bheem cartoon pogo boy chhota bheem cartoon p